

# TC53 and TC58 Accessories Guide

Powering a new generation  
of data collection

Revised Feb 2023

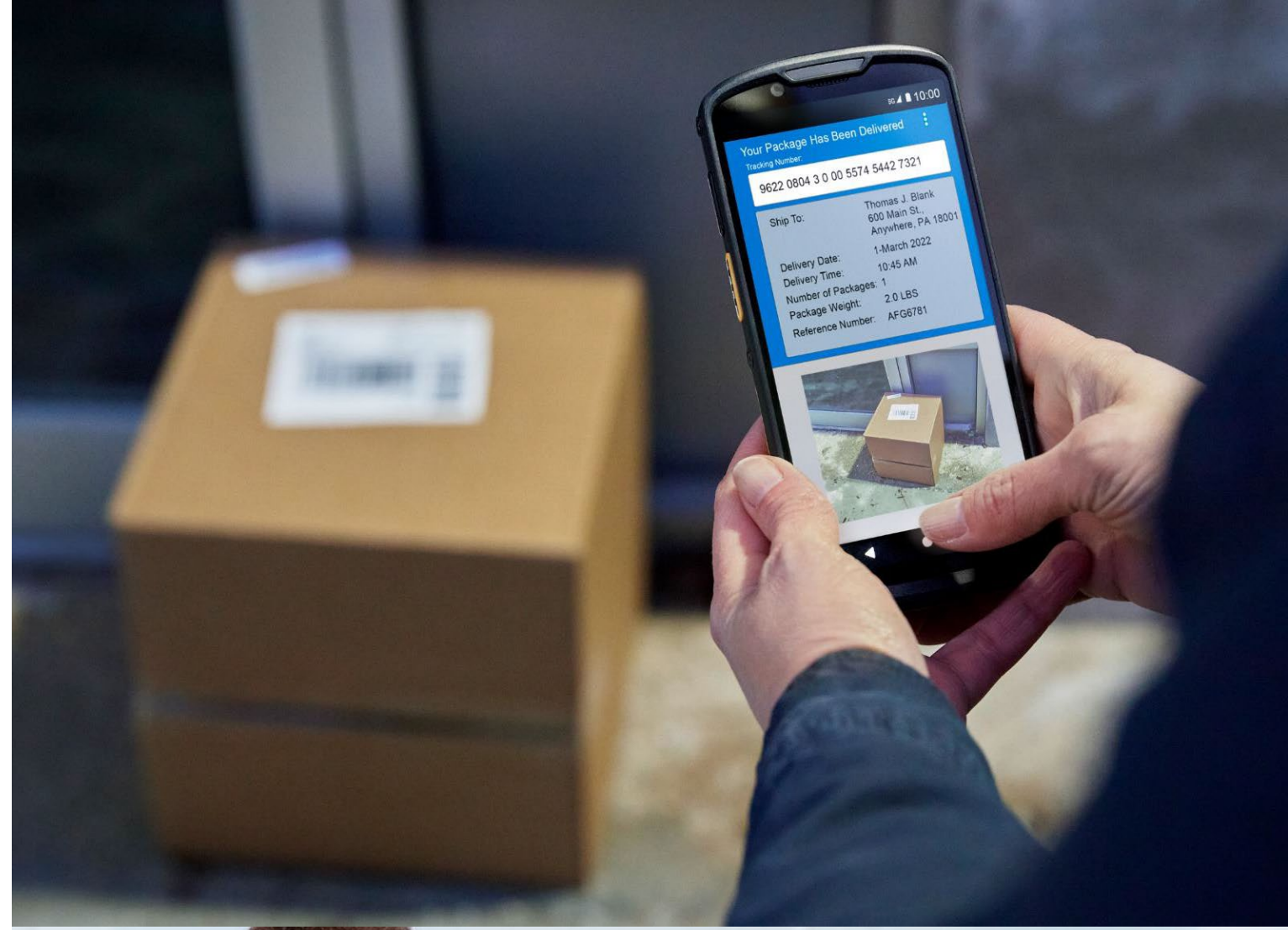



<b>I.</b>	<b>Accessories that POWER devices</b>	
<b>1</b>	<b>Cradles</b>	
1.1	Single-slot chargers	3
1.2	Multi-slot chargers	4
1.3	Mounting options for chargers	5
<b>2</b>	<b>Batteries</b>	
2.1	<b>NEW: Spare Li-ion batteries with BLE Beacon</b>	5
2.2	Spare Li-ion batteries	5
2.3	Spare battery chargers	6
<b>3</b>	<b>Power supply, cables, and adapters</b>	
3.1	Power supply and cable matrix	7
3.2	Country-specific AC line cords	8
<b>4</b>	<b>Vehicle chargers and accessories</b>	10
<b>II.</b>	<b>Accessories that ENABLE productivity solutions</b>	
<b>5</b>	<b>Vehicle holders and mounts</b>	11
<b>6</b>	<b>Headsets</b>	
6.1	Wired headsets and accessories for Workforce Connect	12
6.2	Wired headsets and accessories for voice-directed picking	13
6.3	Wireless headsets and accessories for voice-directed picking	13
<b>7</b>	<b>Wearable mounts and other accessories</b>	
7.1	Wrist mount and straps	14
7.2	Hand straps, carrying (belt) clip, and stylus	16
<b>8</b>	<b>Trigger handles</b>	
8.1	<b>NEW: Electronic trigger handle</b>	17
<b>9</b>	<b>Cables and adaptors</b>	18
<b>III.</b>	<b>Accessories that PROTECT devices</b>	
<b>10</b>	<b>Soft holsters, rugged boots, and screen protectors</b>	19
<b>IV.</b>	<b>Workstation Connect Cradles</b>	20

## Cradles



### Single-slot charger

SKU# CRD-NGTC5-2SC1B

Single-slot charge-only ShareCradle kit. Charges a single device and any TC53/TC58 spare Li-ion battery.

- Device with standard battery charges from 0–80% in about 1½ hours.
- Includes: Power supply [SKU# PWR-BGA12V50W0WW](#) and DC cable [SKU# CBL-DC-388A1-01](#). Two Inserts/shims — one for device without rugged boot, and another for device with rugged boot.
- Sold separately: Country-specific AC line cord (listed later in this document).



### Single-slot USB/Ethernet capable charger

SKU# CRD-NGTC5-2SE1B

Single-slot charge and USB ShareCradle kit. Charges a single device and any TC53/TC58 spare Li-ion battery.

- Device with standard battery charges from 0–80% in about 1½ hours.
- Includes: Power supply [SKU# PWR-BGA12V50W0WW](#) and DC cable [SKU# CBL-DC-388A1-01](#). Two Inserts/shims — one for device without rugged boot, and another for device with rugged boot.
- Sold separately: Country-specific AC line cord (listed later in this document), micro-USB cable [SKU# 25-124330-01R](#), and USB to Ethernet module kit [SKU# KT-TC51-ETH1-01](#).



### USB to Ethernet module kit

SKU# KT-TC51-ETH1-01

Connects single-slot charge/USB charger to a local area network via Ethernet over USB.

- 10/100/1000 Mbps speed with LEDs on module to indicate connectivity and speed.
- Mechanical switch to choose micro-USB port or RJ45 Ethernet.
- Includes: USB-Ethernet Module [SKU# MOD-MT2-EU1-01](#) and support bracket [SKU# BRKT-TC51-ENET1-01](#).

#### NOTE

- All TC53/TC58 cradles accommodate devices with or without the rugged boot.
- Each cradle cup has two inserts/shims, one of which must be installed prior to inserting the device with or without rugged boot.
- Spare cradle cups are available as service spare parts.

## Cradles



### Five-slot charger

SKU# CRD-NGTC5-5SC5D

Charge-only ShareCradle kit to charge five devices.

- Can be mounted in a standard 19-inch rack system using mounting bracket [SKU# BRKT-SCRD-SMRK-01](#).
- Device with standard battery charges from 0–80% in about 1½ hours.
- **Includes:** Power supply [SKU# PWR-BGA12V108W0WW](#) and DC cable [SKU# CBL-DC-381A1-01](#). 5-pack of two Inserts/shims — one for device without rugged boot, and another for device with rugged boot.
- **Sold separately:** Country-specific AC line cord (listed later in this document).



### Five-slot Ethernet charger

SKU# CRD-NGTC5-5SE5D

Five-slot charge/Ethernet ShareCradle kit. Charges five devices with network speeds of up to 1 Gbps.

- Device with standard battery charges from 0–80% in about 1½ hours.
- **Includes:** Power supply [SKU# PWR-BGA12V108W0WW](#) and DC cable [SKU# CBL-DC-381A1-01](#). 5-pack of two Inserts/shims — one for device without rugged boot, and another for device with rugged boot.
- **Sold separately:** Country-specific AC line cord (listed later in this document).



### Five-slot charger

SKU# CRD-NGTC5-5SC4B

Charge-only ShareCradle kit to charge four devices and any four TC53/TC58 spare Li-ion batteries.

- Can be mounted in a standard 19-inch rack system using mounting bracket [SKU# BRKT-SCRD-SMRK-01](#).
- Device with standard battery charges from 0–80% in about 1½ hours.
- **Includes:** Power supply [SKU# PWR-BGA12V108W0WW](#) and DC cable [SKU# CBL-DC-381A1-01](#). 4-pack of two Inserts/shims — one for device without rugged boot, and another for device with rugged boot.
- **Sold separately:** Country-specific AC line cord (listed later in this document).

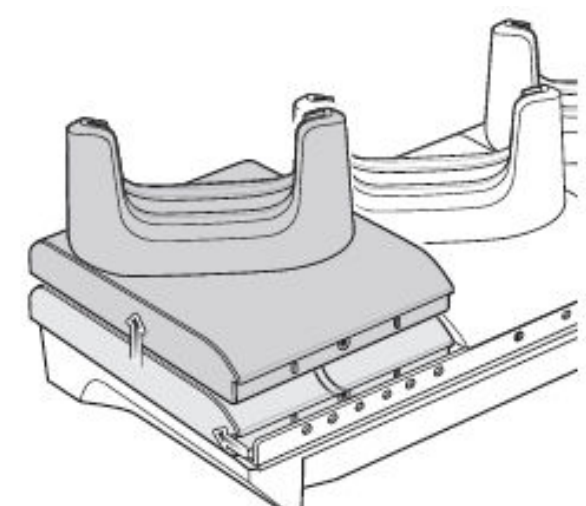

### Device cradle cup replacement kit

SKU# CRDCUP-NGTC5-01

One TC53/TC58 device cradle cup replacement kit with two inserts/shims.

- Can be used to replace a TC5x series device cup on ShareCradle when upgrading to TC53/58.
- **Includes:** Two Inserts/shims — one for device without rugged boot, and another for device with rugged boot.
- **Also available as a 5-pack** — 5 device cradle cups and 10 inserts/shims — [SKU# CRDCUP-NGTC5-05](#).



## Mounting options for chargers



### Rack mounting for space optimization

Optimize available space by mounting any set of five-slot chargers for TC5X on a standard, 19-inch server rack.

- Ideal for customers that have several devices per location.
- Compatible with all five-slot chargers for TC5X.



### Mounting bracket

SKU# BRKT-SCRD-SMRK-01

Use five-slot ShareCradle mounting bracket to attach five-slot TC5X cradles to the wall or mount on a 19-inch server rack.

- Offers cable routing slots and removable tray that stores / conceals power supply.
- Adjustable orientations:
  - 25° angle for high-density (five-slot chargers).
  - Horizontal (single-slot or four-slot spare Li-ion charger).

## Spare Li-ion batteries



### New: BLE battery with PowerPrecision Plus

SKU# BTRY-NGTC5TC7-44MABLE-01

Standard capacity 4,400 mAh battery with PowerPrecision Plus and BLE beacon.

- Premium-grade battery cells with longer lifecycle and tested to meet rigorous controls and standards.
- Obtain advanced battery state of health information including charge level and battery age based on usage patterns.
- BLE beacon allows device with this battery to be located even if powered off using [Zebra Device Tracker](#).
- Sold separately: Zebra Device Tracker licenses for either 1-year SKU# SW-BLE-DT-SP-1YR or 3-years SKU# SW-BLE-DT-SP-3YR.

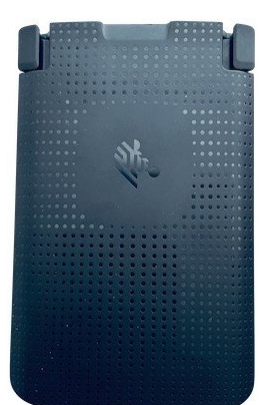

Also available: standard battery with PowerPrecision Plus, but without Device Tracker as SKU# BTRY-NGTC5TC7-44MA-01

- Same robust housing as the version with BLE beacon for optimal performance and durability.
- Same advanced battery state of health features as BLE battery.

## Spare Li-ion batteries



### Extended capacity battery with PowerPrecision Plus

SKU# [BTRY-NGTC5TC7-66MA-01](#)

Extended capacity 6,600 mAh battery with PowerPrecision Plus.

- Premium-grade battery cells with longer lifecycle and tested to meet rigorous controls and standards.
- Obtain advanced battery state of health information including charge level and battery age based on usage patterns.



### Wireless charging battery with PowerPrecision Plus

SKU# [BTRY-NGTC5TC7-44MAWC-01](#)

TC58 Standard capacity 4,400 mAh battery with Wireless charging and PowerPrecision Plus.

- Premium-grade battery cells with longer lifecycle and tested to meet rigorous controls and standards.
- Obtain advanced battery state of health information including charge level and battery age based on usage patterns.
- Works great with TC58 wireless charging vehicle cradle [SKU# CRD-TC58-WCVC-01](#) (listed later in this document).

Compatibility	
TC53	No
TC58	Yes (Premium only)

## Spare battery charger

### Battery charger

SKU# [SAC-NGTC5TC7-4SCHG](#)

Spare battery charger to charge any four spare Li-ion batteries.

- Standard capacity 4,400 mAh batteries charge from 0–90% in about 4 hours.
- Sold separately: Power Supply SKU# [PWR-BGA12V50W0WW](#), DC Cable [SKU# CBL-DC-388A1-01](#) and Country-specific AC Line cord (listed later in this document).



### 4 spare battery chargers can be mounted as shown with mounting bracket [SKU# BRKT-SCRD-SMRK-01](#)

Use to mount to wall or with standard 19" server rack for more density and save space.





## Power supply, cables, and adaptors

### Power supply and cable matrix

SKU#	Description	Note
<a href="#">PWR-BGA12V108W0WW</a>	Level VI AC/DC power supply brick. AC Input: 100–240V, 2.8A. DC Output: 12V, 9A, 108W.	Included in: <ul style="list-style-type: none"> <li>• <a href="#">CRD-NGTC5-5SC5D</a></li> <li>• <a href="#">CRD-NGTC5-5SE5D</a></li> <li>• <a href="#">CRD-NGTC5-5SC4B</a></li> </ul>
<a href="#">CBL-DC-381A1-01</a>	DC line cord for running multi-slot cradles from a single Level VI power supply.	
<a href="#">PWR-BGA12V50W0WW</a>	Level VI AC/DC power supply brick. AC Input: 100-240V, 2.4A. DC Output: 12V, 4.16A, 50W.	Included in: <ul style="list-style-type: none"> <li>• <a href="#">CRD-NGTC5-2SC1B</a></li> <li>• <a href="#">CRD-NGTC5-2SE1B</a></li> </ul>
<a href="#">CBL-DC-388A1-01</a>	DC line cord for running single-slot cradles or battery chargers from a single Level VI power supply.	Sold separately. Use for <a href="#">SAC-NGTC5TC7-4SCHG</a> .
<a href="#">CBL-TC5X-USBC2A-01</a>	USB C to USB A communications and charging cable, 1m long	<b>Sold separately. Use to:</b> <ul style="list-style-type: none"> <li>• Directly charge TC53 / TC58 using a wall wart</li> <li>• Connect TC53 / TC58 to a computer (developer tools)</li> <li>• Charge TC53 / TC58 in a vehicle (can be used with cigarette light adapter <a href="#">SKU# CHG-AUTO-USB1-01</a>, if needed)</li> </ul>
<a href="#">CBL-TC2Y-USBC90A-01</a>	USB C to USB A cable with 90° bend in USB-C adapter	
<a href="#">25-124330-01R</a>	Micro USB active-sync cable. Allows for active-sync connectivity between the mobile computer single- or two-slot cradle and a host device.	<b>Sold separately.</b> Required for use with <a href="#">SKU# CRD-NGTC5-2SE1B</a> if syncing with a computer is desired while TC53 / TC58 is in the charger.
<a href="#">CBL-DC-523A1-01</a>	DC Y-line cord for running two spare battery chargers to a single Level VI power supply <a href="#">SKU# PWR-BGA12V108W0WW</a> .	<b>Sold separately. Use to:</b> Consolidate power supplies for multiple spare battery chargers proximally placed to each other.
<a href="#">PWR-WUA5V12W0XX</a>	USB type A power supply adaptor (wall wart). Replace 'XX' in SKU as follows to get the right plug style based on region:  <b>US</b> (United States) • <b>GB</b> (United Kingdom) • <b>EU</b> (European Union) <b>AU</b> (Australia) • <b>CN</b> (China) • <b>IN</b> (India) • <b>KR</b> (Korea) • <b>BR</b> (Brazil)	<b>Sold separately.</b> Use with a communications & charge cable to directly charge TC53 / TC58 device drawing power from a wall socket.

#### NOTE

Adaptors and cables related to vehicle charging are listed later in this document.

# Accessories that power devices



## Power supply, cables, and adaptors

### Country-specific AC line cords: grounded, 3-prong

SKU#	Country / region	Note
<a href="#">23844-00-00R</a>	North America (United States, Canada, Mexico)	7.5 feet long Commonly used with chargers mounted in server racks
<a href="#">50-16000-678R</a>	North America (United States, Canada, Mexico)	3 feet long
<a href="#">50-16000-221R</a>	North America (United States, Canada, Mexico)	6 feet long
<a href="#">50-16000-727R</a>	Brazil	1.8 meters (6 feet) long
<a href="#">50-16000-680R</a>	Argentina	1.8 meters (6 feet) long
<a href="#">50-16000-217R</a>	American Samoa, Australia, New Guinea	1.8 meters (6 feet) long
<a href="#">50-16000-218R</a>	Japan	1.8 meters (6 feet) long
<a href="#">50-16000-219R</a>	Antigua, Bermuda, Burma, Channel Islands, Hong Kong, Iraq, Ireland, Malaysia, North Ireland, Scotland, Singapore, United Kingdom, Wales	1.8 meters (6 feet) long
<a href="#">50-16000-257R</a>	China	1.8 meters (6 feet) long
<a href="#">50-16000-220R</a>	Europe, Abu Dhabi, Bolivia, Dubai, Egypt, Iran, Korea, Russia, Vietnam	1.8 meters (6 feet) long
<a href="#">50-16000-671R</a>	Italy	1.8 meters (6 feet) long
<a href="#">50-16000-669R</a>	India, S. Africa, Africa	1.8 meters (6 feet) long

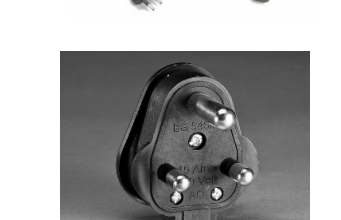



# Accessories that power devices



## Power supply, cables, and adaptors

### Country-specific AC line cords: ungrounded, 2-prong

SKU#	Country / region	Note
<a href="#">50-16000-182R</a>	United States	Type A NEMA 1-15 plug
<a href="#">50-16000-255R</a>	Europe, Abu Dhabi, Bolivia, Dubai, Egypt, Iran, Korea, Russia, Vietnam.	Type C CEE7/16 plug
<a href="#">50-16000-670R</a>	Bermuda, England, Hong Kong, Iraq, Ireland, Malaysia, North Ireland, Scotland, Singapore, United Kingdom, Wales	



## Vehicle chargers and accessories



### Wireless charger for vehicles

SKU# CRD-TC58-WCVC-01

TC58 Wireless charger for vehicles.

- Can be mounted using four AMPS-pattern holes.
- Includes a holder for stylus that can be installed either to the left or right of device in cradle. (Can also be removed if not needed.)
- Requires: Rugged Boot [SKU# SG-NGTC5EX01-1](#) and TC58 premium device with wireless battery [SKU# BTRY-NGTC5TC7-44MAWC-01](#). All sold separately.
- For mounting options: see [Vehicle Holders and Mounts](#) listed later in this document.

Compatibility	
TC53	No
TC58	Yes (Premium only)



### Cigarette lighter adapter plug

SKU# CHG-AUTO-USB1-01

USB cigarette lighter adapter plug.

- Used with USB C Cable ([CBL-TC5X-USBC2A-01](#)) to charge device.
- Includes two USB A ports providing higher current (5V, 2.5A) for faster charging.

#### NOTE

For mounting options and non-powered vehicle holders, please see section titled, "[Vehicle Holders and Mounts](#)", in this document.

For charging cables that can be used with vehicle holders, please see section titled, "[Power Supply, Cables, and Adaptors](#)", in this document.



# Accessories that enable productivity solutions



## Vehicle holders and mounts



### Vehicle holder

**SKU# CRD-TC5NG-NCCD-01**

Non-powered vehicle holder.

- Holds device in vehicle installations.
- Spring tension on holder and does not support Pistol Grip Handle.
- Provides access to USB-C port on bottom of device allowing device to be charged.
- Requires device with rugged boot [SKU# SG-NGTC5EXO1-01](#).
- Available for mounting using [SKU# RAM-B-166U](#).



### Vehicle mounting hardware

**SKU# RAM-B-166U**

Vehicle cradle windshield suction cup mount.

- RAM twist lock suction cup with double socket arm and diamond base adapter.
- Overall length: 6.75".
- Attaches to back of vehicle cradles.



### Vehicle mounting hardware

**SKU# RAM-B-238U**

Vehicle cradle RAM mount ball.

- RAM 2.43" x 1.31" diamond ball base w/ 1" ball.
- Attaches to back of vehicle cradles.



### Vehicle mounting hardware

**SKU# 3PTY-PCLIP-241478**

ProClip forklift/vehicle cradle clamp mount – for square frame mounting.

- Attaches to square bars of vehicles/forklifts.
- Clamp is 5.125" x 3.75" and can accommodate bars of varying thicknesses.
- 6" long arm on clamp uses AMPS hole pattern for mounting ProClip cradles like [SKU# 3PTY-PCLIP-241475](#).

# Accessories that enable productivity solutions



## Headsets

### Close gaps, Open possibilities with Workforce Connect

Usher in a new era of transformation—one led by your frontline and powered by Zebra Workforce Connect. One where communication and information flows freely and gaps between teams, workflows and data are closed.

With Workforce Connect, hindered workers become effective problem solvers, contributing their best. Critical workflows are streamlined in one place, on one device, equipping workers with the information they need, right at their fingertips.

Only Zebra offers the most complete lineup of software and rugged hardware with the scalability, support and service needed to make the greatest impact where it counts—on the frontline.

[Learn more about you can elevate your frontline workers with Zebra Workforce Connect.](#)

#### Wired headsets for Workforce Connect



##### SKU# HDST-USBC-PTT1-01

PTT headset with USB-C connector; one-piece solution.

- For Push-To-Talk (PTT) applications with volume up/volume down/PTT buttons. Compatible with PTT Express/PTT Pro.
- Rotating earpiece allows for right or left ear configuration. Mono headset with microphone.
- Includes clip for attaching PTT button to clothing.

Compatibility	
TC53	Yes
TC58	Yes

#### Wired headsets for Workforce Connect



##### SKU# HDST-35MM-PTT1-01

PTT and VoIP headset with 3.5mm standard jack.

- For Push-To-Talk (PTT) and VoIP telephony. Compatible with PTT Express/PTT Pro.
- Rotating earpiece allows for right or left ear configuration. Mono headset with microphone.
- Includes clip for attaching PTT button to clothing.

Compatibility	
TC53	Yes
TC58	No

#### Wired headsets for Workforce Connect



##### SKU# HDST-35MM-PTVP-01

PTT and VoIP headset with 3.5mm locking jack.

- For Push-To-Talk (PTT) and VoIP telephony. Compatible with PTT Express/PTT Pro.
- Built-in cord wrap with rotating earpiece allows for right or left ear configuration. Mono headset with microphone.
- Includes clip for attaching PTT button to clothing.
- Sold separately: Requires 3.5mm keyed/collared female to 3.5mm male headset adapter cable [SKU# CBL-TC51-HDST35-01](#).

Compatibility	
TC53	Yes
TC58	No



# Accessories that enable productivity solutions



## Headsets

### Rugged Bluetooth and corded HD voice headsets for the most demanding industrial environments

When it comes to enabling speech-driven applications and voice communications in warehouses, manufacturing plants and outdoor yards, you need a headset that is specially designed for the job. The HS3100 Bluetooth and HS2100 corded headsets are loaded with features that offer everything you need in an industrial headset.

[Learn more about how these headsets deliver a superior voice experience.](#)

#### Wired headsets for voice-directed picking

##### HS2100 rugged wired headset

Corded HD voice headset.

- Dustproof, spray proof, and waterproof.
- Noise cancellation for a superior voice experience in the noisiest environments.
- Swiveling boom mutes microphone allowing user to prevent voice pick applications from recognizing non-voice pick conversations.
- Feather-light for extraordinary comfort.

Compatibility	
TC53	Yes
TC58	No

SKU#	Description
<a href="#">HS2100-OTH</a>	HS2100 Rugged Wired Headset Over-The-Head Headband includes HS2100 Boom Module and HSX100 OTH Headband Module
<a href="#">HS2100-BTN-L</a>	HS2100 Rugged Wired Headset (Behind-the-neck headband left)
<a href="#">HS2100-OTH-SB</a>	HS2100 Rugged Wired Headset (Over-the-head headband) includes HS2100 Shortened Boom Module and HSX100 OTH headband module
<a href="#">HS2100-BTN-SB</a>	HS2100 Rugged Wired Headset (Behind-the-neck headband left) includes HS2100 Shortened Boom Module and HSX100 BTN headband module

#### Wireless headsets for voice-directed picking

##### HS3100 rugged Bluetooth headset

Bluetooth headset for voice-directed picking applications.

- Noise cancellation tuned for Voice-Directed Picking applications.
- Swap batteries on the fly — without losing the Bluetooth connection.
- Split-second tap-to-pair simplicity using NFC. 15 hours of battery power.

SKU#	Description
<a href="#">HS3100-OTH</a>	HS3100 Rugged Wired Headset Over-The-Head Headband includes HS3100 Boom Module and HSX100 OTH Headband Module
<a href="#">HS3100-BTN-L</a>	HS3100 Rugged Wired Headset (Behind-the-neck headband left)
<a href="#">HS3100-OTH-SB</a>	HS3100 Rugged Wired Headset (Over-the-head headband) includes HS3100 Shortened Boom Module and HSX100 OTH headband module
<a href="#">HS3100-BTN-SB</a>	HS3100 Rugged Wired Headset (Behind-the-neck headband left) includes HS3100 Shortened Boom Module and HSX100 BTN headband module
<a href="#">HS3100-SBOOM-01</a>	HS3100 Shortened Boom Module (includes microphone boom, battery and windscreen)



## Wearable mounts and other accessories



### Wrist mount and straps

SKU# [SG-NGTC5-WMADP1-01](#)

Wrist mount with standard strap.

- Swivel design allows device to be viewed in portrait or landscape mode enabling hands-free functionality.
- Velcro-free design uses non-absorbent materials that can be wiped down.
- Strap length can be adjusted between 128 to 191 mm (approx. 5.0 to 7.5").
- Includes Carrier, Comfort Pad [SKU# SG-NGWT-CMPD-01](#) and Small/Medium sized Wrist Strap [SKU# SG-NGWT-WSTPST-01](#).
- Requires rugged boot [SKU# SG-NGTC5EXO1-01](#) installed on device.



### Wrist mount and straps

Also available with extended strap [SKU# SG-NGTC5-WMADP1-02](#)

Wrist mount with extended strap.

- Includes: Medium/Large size wrist strap [SKU# SG-NGWT-WSTPLN-01](#).
- Strap length can be adjusted between 164 to 265 mm (approx. 6.5 to 10.5").
- Requires rugged boot [SKU# SG-NGTC5EXO1-01](#) installed on device.



### Wrist mount and straps

SKU# [SG-NGWT-CMPD-02](#)

Replacement comfort pad for wrist mount.

- Soft rubber, easily removable, and hygienic.
- Improved design vs. [SKU# SG-NGWT-CMPD-01](#), which now includes ridges in the top surface that assists with alignment during installation and reduces the occurrence of slippage, especially in the presence of sweat.



## Wearable mounts and other accessories



### Wrist mount and straps

SKU# SG-NGWT-WSTPST-01

Replacement wrist strap – standard size.

- White dial and accent color on strap identify size as standard (small/medium).
- Strap length can be adjusted between 128 to 191 mm (approx. 5.0 to 7.5").



### Wrist mount and straps

SKU# SG-NGWT-WSTPLN-01

Replacement wrist strap – extended size.

- Black dial and accent color on strap identify size as extended (medium/large).
- Strap length can be adjusted between 164 to 265 mm (approx. 6.5 to 10.5").



### Wrist mount and straps

SKU# SG-NGWT-WSTPXL-01

Replacement wrist strap – extra-large size.

- Blue dial and accent color on strap identify size as extra-large.
- Strap length can be adjusted between 218 to 375 mm (approx. 8.5 to 14.75").



### Arm sleeve

SKU# SG-WT4027050-01R

Arm sleeve – pack of 5.

- Worn under wrist mount strap if worker is in short-sleeved shirt and wants:
  - Extra sweat wicking/ personal layer
  - Extra comfort
  - Extra slip-resistance
- Material will not snag. One size fits all.
- Washable in mild detergent. Should be air dried.

## Wearable mounts and other accessories



### Hand straps

SKU# [SG-NGTC5TC7-HDSTP-03](#)

Hand strap – Pack of 3.

- Allows device to be easily held in palm of hand.
- Attaches directly to device, even with rugged boot installed.
- Includes loop for holding optional stylus.
- Sold separately: Rugged boot [SKU# SG-NGTC5EXO1-01](#).



### Stylus

SKU# [SG-STYLUS-TCX-MTL-03](#)

Fiber tipped stylus – pack of 3.

- Heavy-duty and made from stainless steel / brass. No plastic parts – real pen feel. Can be used in rain.
- Micro-knit, hybrid-mesh, fiber tip provides silent, smooth gliding use. 5" length.
- Big improvement over rubber tipped or plastic tipped stylus.
- Compatible with all capacitive touch screen devices.
- Tether to device or hand strap using [SKU# SG-TC5NGTC7NG-TETHR-03](#).



### Stylus tether

SKU# [SG-TC5NGTC7NG-TETHR-03](#)

Stylus tether.

- Can be attached to device tower bar.
- When hand strap is used, tether should attach to hand strap [SKU# SG-NGTC5TC7-HDSTP-03](#) directly (not to terminal towel bar).
- String type tether prevents loss of stylus.
- NOTE: Other Zebra coiled tethers are not recommended for use with TC53/TC58 as they may interfere with other accessories.



## Trigger handles and accessories



### New: Electronic trigger handle

SKU# TRG-NGTC5-ELEC-01

Pistol-grip trigger handle.

- Uses electrical trigger via contacts on back side of TC53/TC58.
- Trigger handle accessory offers customers the option of using the product in a gun form factor, ideal for scan-intensive situations.
- Requires rugged boot [SKU# SG-NGTC5EXO1-01](#) and device for attachment.
- Does not block access to rear facing camera and flash allowing camera to be used while using the trigger handle.
- Compatible with both standard and extended capacity batteries.
- Sold separately: Optional wrist strap [SKU# SG-PD40-WLD1-01](#).

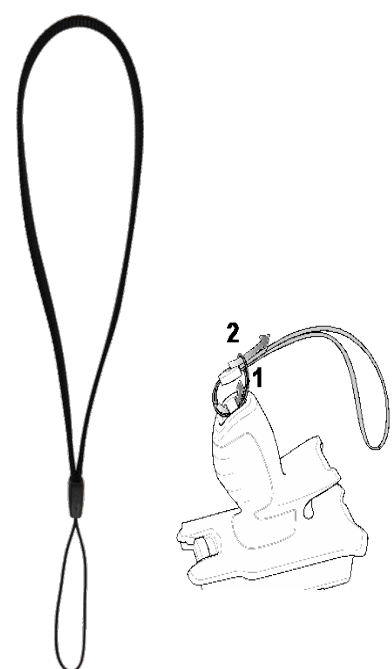

### Trigger handle wrist strap

SKU# SG-PD40-WLD1-01

Looping wrist strap for trigger handle.

- Attaches to bottom of pistol-grip trigger handle.

# Accessories that enable productivity solutions



## Cables and adaptors



### Cradle to USB cable

SKU# 25-124330-01R

Single slot cradle to PC/host USB cable.

- Used with single-slot cradle.
- Micro-USB connection on cradle end.



### Adaptor cable

SKU# CBL-TC51-HDST35-01

3.5mm collared female to 3.5mm male headset adapter cable.

- Provides a collared/keyed 3.5mm barrel jack connector.
- Required for use with some headsets (i.e., HS2100) that use a locking keyed connector on the headset jack.
- Cable is approximately 6" long.
- Includes retention/anti-rotation lock [SKU# ADP-LOCK-3.5HT1-01](#).



### Adaptor cable

SKU# ADP-35M-QDCBL1-01

RCH50/RCH51 quick disconnect headset adaptor cable.

- Connects RCH50/RCH51 headset (or headsets with quick disconnect connector) to devices with 3-pole 3.5mm barrel jack connector.
- Requires 3.5mm keyed/collared female to 3.5mm male headset adapter cable [SKU# CBL-TC51-HDST35-01](#).
- Cable features a rugged keyed/collared jack for a locking fail-safe connection.



### Adaptor cable

SKU# CBL-HS2100-3MS1-01

HS2100 headset standard cable – 3.5mm jack.

- 3.5mm barrel jack connector with cable length 43" (1.1m)
- For use with TC5X, TC7X, TC8000, or other devices using a 3.5mm barrel jack audio connector. Requires [SKU# CBL-TC51-HDST35-01](#).
- Rugged cable with rugged connectors that are keyed/collared for a locking failsafe connection.
- Includes one clothing clip. Additional clips can be purchased separately.



# Accessories that enable productivity solutions



## Cables and adaptors

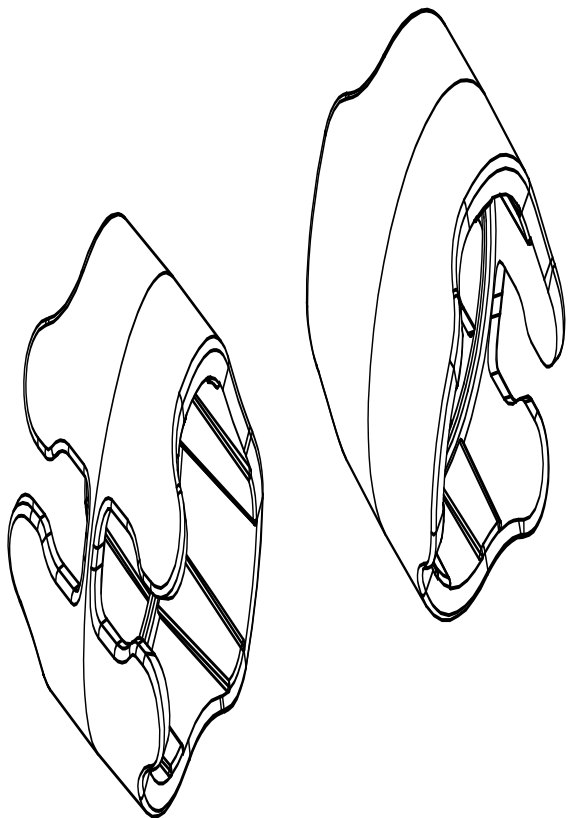

### Adaptor lock

SKU# ADP-LOCK-3.5HT1-01

Spare 3.5mm audio adaptor retention & anti-rotation lock.

- This clip is used with the collared female to male headset adapter cable [SKU# CBL-TC51-HDST35-01](#) and keyed headset cables to prevent cable rotation/spinning. Also provides a secure, reliable headset connection.
- Clip is normally included with the collared female to male headset adapter cable, this is a spare/replacement clip/lock.
- **Note:** This is a spare/service parts item. Contact an authorized Zebra reseller to order.

Compatibility	
TC53	Yes
TC58	No

## Soft holsters, rugged boots, and screen protectors



### Soft holster

SKU# SG-NGTC5TC7-HLSTR-01

Soft holster.

- Vertical orientation with open bucket design to accommodate TC53/TC58 with optional rugged boot, pistol-grip trigger handle, and/or hand strap.
- Strap on rear of holster allows adjustment for use with the accessory options mentioned above.
- Includes loop for storage of optional stylus. Nonrotating for maximum durability.
- Holster is leather material and includes cut-out for speaker output.
- Also compatible with trigger handle [SKU# TRG-NGTC5-ELEC-01](#) and hand strap [SKU# SG-NGTC5TC7-HDSTP-03](#).



### Rugged boot

SKU# SG-NGTC5EX01-01

Rugged boot.

- Boot increases drop spec of device to 6 feet to concrete.
- Two-piece design provides for an easier installation and snaps together.

## Soft holsters, rugged boots, and screen protectors



### Rugged boot

Rugged boot can be customized to reflect a company's brand identity or corporate design language.

- Available for consideration when a custom product request is submitted by your Zebra sales representative.
- Lead time and cost depend on volume and complexity of color, material, and finish.
- One / two solid colors work best for customization. Not all patterns are achievable.



### Screen protectors

**SKU# SG-NGTC5-SCRNP-03**

Screen protector – pack of 3.

- Tempered glass.
- Includes alcohol wipes, cleaning cloth, and instructions needed for screen protector installation.



## TC53/58 Connect Cradle

Introducing the new **Connect Cradles** (Workstation and Point of Sale) for TC53/TC58 mobile computers. These accessories allow for the TC53/58 mobile computer to connect to multiple purpose-built peripherals and enable Zebra Workstation Connect on an external monitor. The Connect Cradle offers connections for standard workstation setups (monitor, keyboard, mouse) while the point-of-sale configuration provides 3 additional powered USB ports for setups utilizing POS-specific peripherals such as a payment terminal, receipt printer, or scanner.



### Connect Cradles

**SKU# CRD-NTC5X-1SNWS-01 | SKU# CRD-NTC5X-1SNHP-01**

Workstation | Point of Sale

- Workstation: TC53, TC58 Connect Cradle, allows to connect a mobile computer to an external monitor and multiple peripherals, includes HDMI, Ethernet and USB-A (x4) ports.
- Point of Sale: TC53, TC58 Connect Cradle, allows to connect a mobile computer to an external monitor and multiple peripherals, includes HDMI, Ethernet, USB-A (x4), 24V Powered USB (x1), 12V Powered USB (x2) ports.

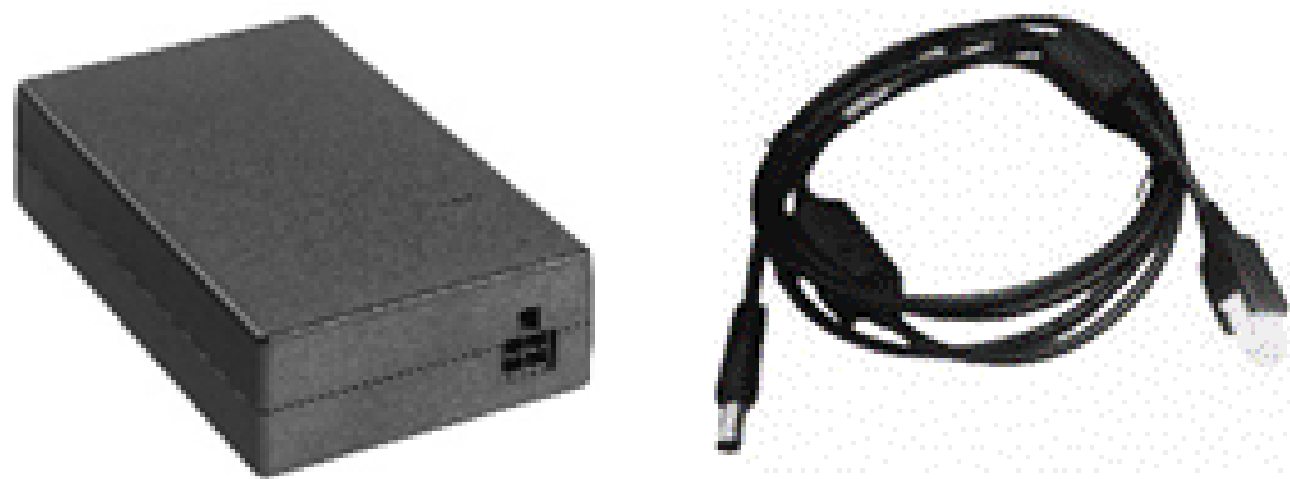

### Power Supply & DC Line Cord

**SKU# PWR-BGA12V50W0WW | SKU# CBL-DC-388A2-01**

Power Supply | DC Line Cord

- Power Supply **PWR-BGA12V50W0WW** for Connect Cradle : 100-240 VAC, 12VDC, 4.16A.
- DC Line Cord **CBL-DC-388A2-01** for above power supply: 12 VDC, 4.16A 1.8m length.



### Power Supply for Point-of-Sale Cradle

**SKU# PWR-BGA24V150W1WW**

Power Supply for POS Cradle

- Level VI AC/DC Power Supply Brick. AC Input: 100-240V, 2.0A. DC Output: 24V, 6.25A, 150W.
- Requires: Country Specific AC grounded line cord.