



Industrial Interface and UART Board

For PX940

Installation Instructions

Introduction

This guide describes the Industrial Interface and UART Board Kit for PX940 Series printers.

Description

The installation instructions describe how to physically install the interface board in a printer and how to configure the serial communication port.

Printer Firmware

The printer must be fitted with Honeywell Fingerprint v8.60 (or later).

Note: *This kit does not work with IPL.*

In Honeywell Fingerprint, the serial ports are addressed as **uart2** (communication channel#2).

Installation Kit

The Industrial Interface and UART Board Kit includes:

- One Industrial Interface and UART Board
- One USB cable
- One spacer screw
- One 3X8mm Torx screw
- Two 4X8mm Torx screws
- Five straps

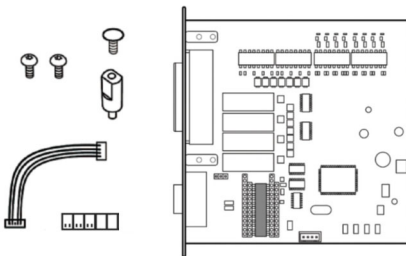

The only tools needed for installation are #T10 and #T20 Torx screwdrivers.

Installing the UART and Industrial Interface



Warning: The installation described in this section must only be performed by an authorized service technician. Honeywell assumes no responsibility for personal injury or damage to the equipment if the installation is performed by an unauthorized person.



Caution: Follow standard ESD guidelines to avoid damaging the equipment.



Caution: Before you begin, turn off the printer and disconnect the power cord and communication cables.

Follow the procedure to physically install UART and Industrial Interface in the printer.

1. Turn off the printer and disconnect the power cord.
2. Open the media cover.
3. Use the T20 screwdriver to remove the two screws that secure the electronics cover to the inside of the printer base.

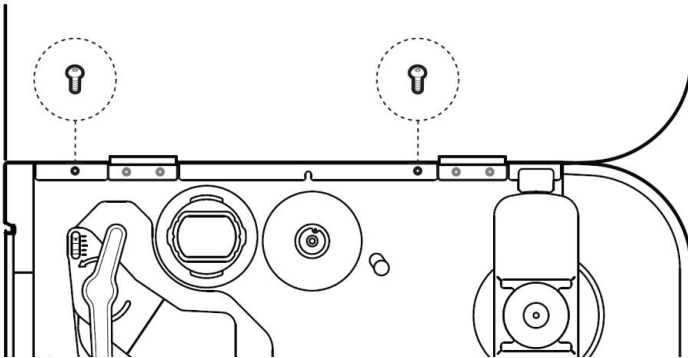

4. Close the media cover.
5. Remove the two screws located on the outside of the electronics cover.



6. Remove the electronics cover.
7. On the back of the printer, remove the two screws that secure the cover plate to the printer, and remove the cover plate.

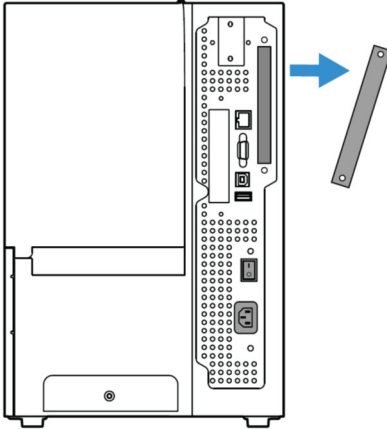

8. Use the T10 screwdriver to remove the screw located on the top of the printer main board and attach the space saver screw.

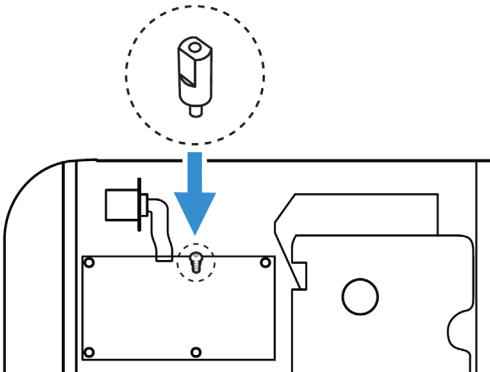

9. Insert the Industrial Interface and UART Board into the printer and secure the board assembly to the printer with two screws.

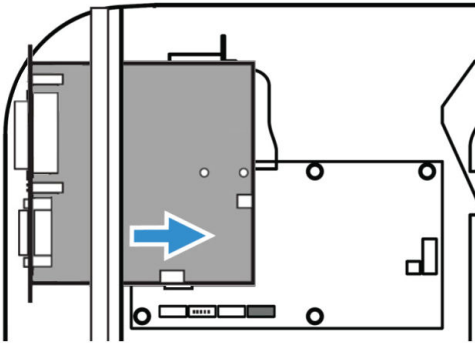

10. Secure the optional board assembly to the spacer with a Torx screw.
11. Insert the USB cable into the J37 connector on the printer main board. Then insert the other end into the J13 connector on the Industrial Interface and UART Board.

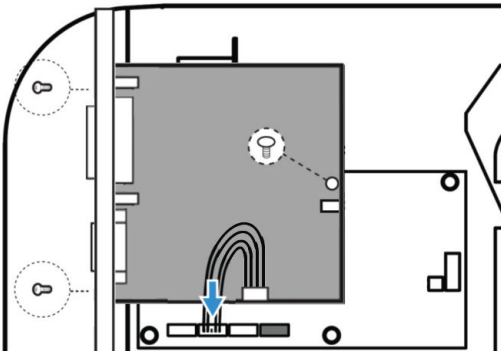

12. Fit straps and circuits on the board to configure the type of serial communication you want to use. For more details, see Serial Interface.
13. Put the cover back on and secure it with the 4 screws.

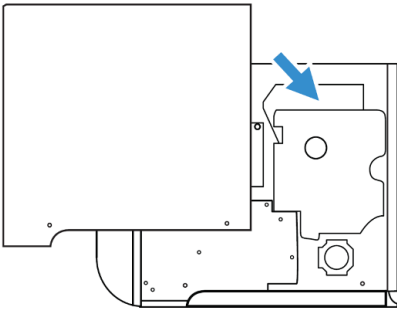

Serial Interface

This section describes how to modify the interface board for RS-232 (standard), RS-422 isolated/full duplex, or RS-485 isolated/half duplex on the “uart2:” port and explains the configuration of the interface connector.

One of the circuits shown below will be needed for the serial communication you want to use.

Serial Communication	Honeywell Part Number	Integrated Circuit	Remark
RS-232 Non-isolated	360-018-001	Maxim 238	Already mounted on the board
RS-422 isolated full duplex	360-027-001	Maxim 1490 full duplex RS485/422 Intfc, 250Kbps RoHS	Not included in the kit, needs to be purchased
RS-485 isolated half duplex	360-026-001	Maxim 1480 half duplex RS485/422 Intfc, 250KBPS RoHS	Not included in the kit, needs to be purchased



Caution: When fitting driver circuit and straps before installing the interface board, make sure the circuit is not fitted upside down. Protect the board and circuits from electrostatic charges.

RS232 Non-isolated (standard)

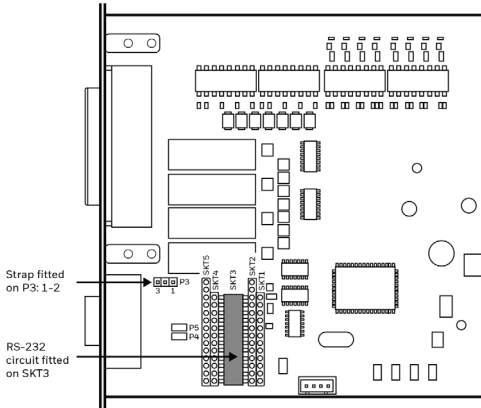

Connector Configuration (RS-232 on “uart2”)

Pin of DB9	Signal Name	Description
1	+5VDC	External +5VDC max 600 mA (automatic switch off at overload, short-circuit protected)
2	TXD	Transmit data
3	RXD	Receive data
4	DSR	Data set ready
5	GND	Ground
6	DTR	Data terminal ready
7	CTS	Clear to send
8	RTS	Request to send
9	-	

RS-232 socket

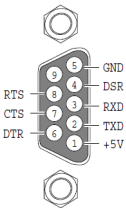

RS-422 Isolated, Full Duplex (reconfiguration required)

Note: The RS-422 circuit is available as a spare part

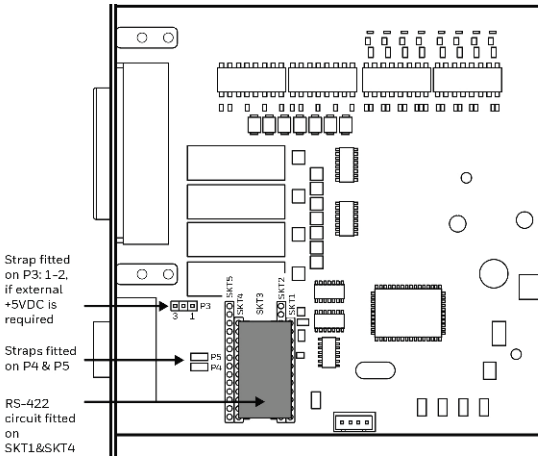

Connector Configuration (RS-422 on “uart2”)

Pin of DB9	Signal Name	Description
1	+5VDC	External +5VDC max 600 mA (automatic switch off at overload, short-circuit protected) provided strap is fitted on P3: 2-3 which spoils the galvanic isolation
2	+TXD	+Transmit data
3	+RXD	+Receive data
4	-	
5	GNDE	Ground
6	-	
7	-RXD	-Receive data
8	-TXD	-Transmit data
9	-	

RS-422 socket

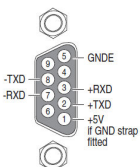

RS-485 Isolated, Half Duplex (reconfiguration required)

Note: The RS-485 circuit is available as a spare part.

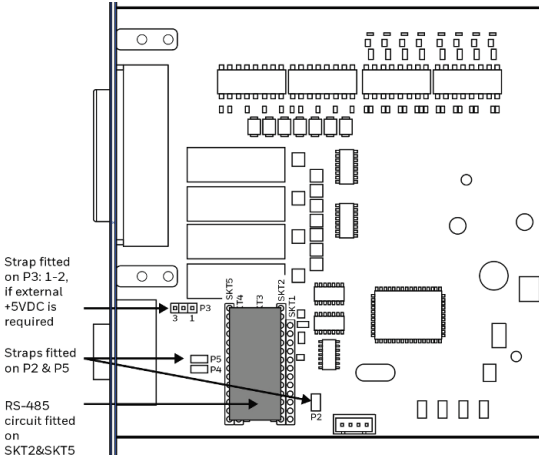

Connector Configuration (RS-485 on “uart2”)

Pin of DB9	Signal Name	Description
1	+5VDC	External +5VDC max 600 mA (automatic switch off at overload, short-circuit protected) provided strap is fitted on P3: 2-3 which spoils the galvanic isolation
2	+DATA	
3	-	
4	-	
5	GNDE	Ground
6	-	
7	-	
8	-DATA	
9	-	

RS-485 socket

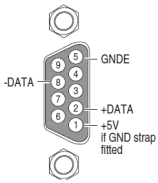

Note: The increased use of LAN networks has made the RS-485 interface somewhat obsolete, because RS-485 requires a special communication protocol and a dedicated wiring system limited to 1,200 m (4,000 ft). We only recommend RS-485 for existing applications and advise the customer to consider a LAN network solution for new applications.

Industrial Interface

The Industrial Interface, provides 8 digital IN ports with optocouplers, 8 digital OUT ports with optocouplers, and 4 OUT ports with relays.

The industrial interface has no straps or circuits to be fitted or removed. All signals are available on a DB-44pin socket and the various ports are controlled by the Honeywell Fingerprint instructions PORTIN and PORTOUT ON/OFF.

For more information, see the Honeywell Fingerprint Command Reference Manual at www.honeywellaidc.com.

Digital Opto In

The status of the digital IN ports can be read using the PORTIN functions. If a current is led through the optocoupler of the port, PORTIN returns the value -1 (true) or value 0 (false).

Signal	Description	Min	Typical	Max
Vin (High)	Input voltage high	10V	24V	40V
Vin (Low)	Input voltage low	-1V	0V	1V

Connector Configuration

Pin of DSUB 44	Signal Name	Description	Fingerprint Ref. No.
10	IN1A	Anode Opto In Channel 1+	101
40	IN1K	Cathode Opto In Channel 1-	
26	IN2A	Anode Opto In Channel 2+	102
11	IN2K	Cathode Opto In Channel 2-	
41	IN3A	Anode Opto In Channel 3+	103
27	IN3K	Cathode Opto In Channel 3-	
12	IN4A	Anode Opto In Channel 4+	104
42	IN4K	Cathode Opto In Channel 4-	
28	IN5A	Anode Opto In Channel 5+	105
13	IN5K	Cathode Opto In Channel 5-	
43	IN6A	Anode Opto In Channel 6+	106
29	IN6K	Cathode Opto In Channel 6-	
14	IN7A	Anode Opto In Channel 7+	107
44	IN7K	Cathode Opto In Channel 7-	
30	IN8A	Anode Opto In Channel 8+	108
15	IN8K	Cathode Opto In Channel 8-	

Simplified schematics of a digital IN port:

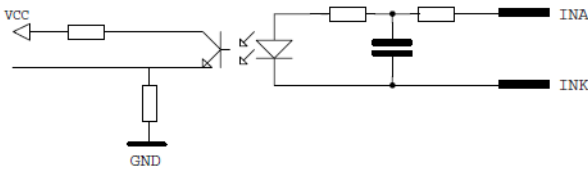

Digital Opto Out

The current to each optocoupler of the digital OUT ports can be turned on and off using PORTOUT ON/OFF statements. The status of the ports can be read using PORTIN functions. If a current is led through the optocoupler of the port, PORTIN returns the value -1 (true), else it returns the value 0 (false).

Signal	Description	Max
V _{ceo}	Collector - emitter Breakdown Voltage	35V
V _{eco}	Emitter - collector breakdown voltage	6V
I _c	Collector current (non-saturation)	30mA

Connector Configuration:

Pin of DSUB 44	Signal Name	Description	Fingerprint Ref. No.
20	OUT_1C	Collector Opto Out Channel 1	221
5	OUT_1E	Emitter Opto Out Channel 1	
35	OUT_2C	Collector Opto Out Channel 2	222
21	OUT_2E	Emitter Opto Out Channel 2	
6	OUT_3C	Collector Opto Out Channel 3	223
36	OUT_3E	Emitter Opto Out Channel 3	
22	OUT_4C	Collector Opto Out Channel 4	224
7	OUT_4E	Emitter Opto Out Channel 4	
37	OUT_5C	Collector Opto Out Channel 5	225
23	OUT_5E	Emitter Opto Out Channel 5	
8	OUT_6C	Collector Opto Out Channel 6	226
38	OUT_6E	Emitter Opto Out Channel 6	
24	OUT_7C	Collector Opto Out Channel 7	227
9	OUT_7E	Emitter Opto Out Channel 7	
39	OUT_8C	Collector Opto Out Channel 8	228
25	OUT_8E	Emitter Opto Out Channel 8	

Simplified schematics of a digital OUT port:

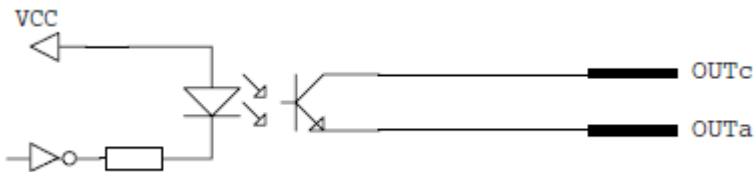

Relays

The relays of the OUT ports can be individually activated using PORTOUT ON/OFF statements. The status of the ports can be read by means of PORTIN functions. If a relay is activated, PORTIN returns the value -1 (true), else it returns the value 0 (false).

Signal	Description	Max
I	Current	1A
Psw AC	Switching power	100VA AC
Usw AC	Switching voltage	100V AC

Connector Configuration:

Pin of DSUB 44	Signal Name	Description	Fingerprint Ref. No.
16	REL1NC	Relay 1 Normally Closed	201
1	REL1NO	Relay 1 Normally Open	
31	REL1COM	Relay 1 Common	
17	REL2NC	Relay 2 Normally Closed	202
2	REL2NO	Relay 2 Normally Open	
32	REL2COM	Relay 2 Common	
18	REL3NC	Relay 3 Normally Closed	203
3	REL13NO	Relay 3 Normally Open	
33	REL3COM	Relay 3 Common	
19	REL4NC	Relay 4 Normally Closed	204
4	REL4NO	Relay 4 Normally Open	
34	REL4COM	Relay 4 Common	

Simplified schematics of a relay OUT port:

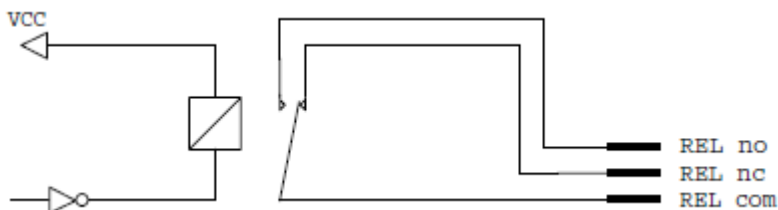

RS

Support

To search our knowledge base for a solution or to log into the Technical Support portal and report a problem, go to www.hsmcontactsupport.com.

User Documentation

For the user guide and other documentation, go to www.honeywellaidc.com.

Limited Warranty

For warranty information, go to www.honeywellaidc.com and click **Get Resources > Product Warranty**.

Patents

For patent information, see www.hsmpats.com.

Disclaimer

Honeywell International Inc. (“HII”) reserves the right to make changes in specifications and other information contained in this document without prior notice, and the reader should in all cases consult HII to determine whether any such changes have been made. The information in this publication does not represent a commitment on the part of HII.

HII shall not be liable for technical or editorial errors or omissions contained herein; nor for incidental or consequential damages resulting from the furnishing, performance, or use of this material. HII disclaims all responsibility for the selection and use of software and/or hardware to achieve intended results.

This document contains proprietary information that is protected by copyright. All rights are reserved. No part of this document may be photocopied, reproduced, or translated into another language without the prior written consent of HII.

Copyright © 2009-2019 Honeywell International Inc. All rights reserved.