



Applicator Interface Board

For PX940

Installation Instructions

Introduction

This guide describes the Applicator Interface kit for PX940 Industrial Series printers.

Description

The installation instructions describe how to physically install and configure the applicator board in the printer.

Printer Firmware

The printer must be fitted with Honeywell Fingerprint v8.60 (or later).

Installation Kit

The Applicator Interface Board installation kit includes:

- One Applicator Interface Board
- One power cable
- One USB cable
- One spacer screw
- One 3X8mm Torx screw
- Two 4X8mm Torx screws

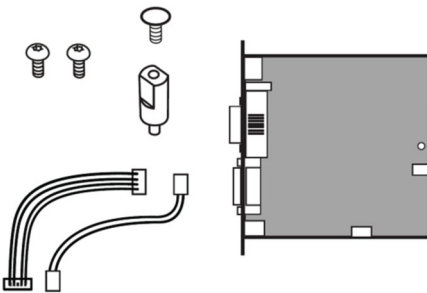

The only tools required for installation are the #T10 and #T20 Torx screwdrivers.

Installing the Applicator Interface Board



Warning: The installation described in this section must only be performed by an authorized service technician. Honeywell assumes no responsibility for personal injury or damage to the equipment if the installation is performed by an unauthorized person.



Caution: Follow standard ESD guidelines to avoid damaging the equipment.



Caution: Before you begin, turn off the printer and disconnect the power cord and communication cables.

Follow the procedure to physically install Applicator Interface Board in the PX940 printer.

1. Turn off the printer and disconnect the power cord.
2. Open the media cover.

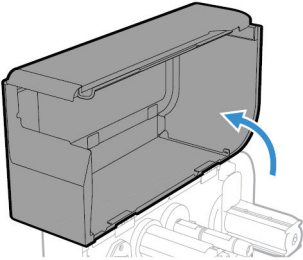

3. Use the T20 screwdriver to remove the two screws securing the electronics cover to the inside of the printer base.

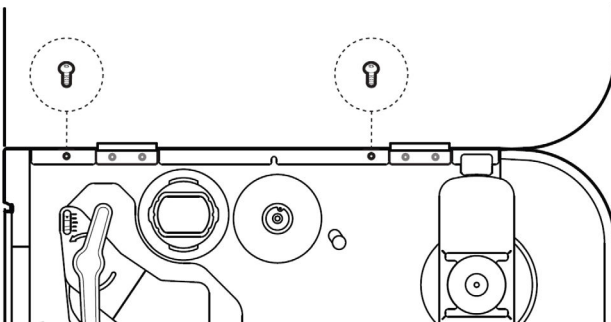

4. Close the media cover.
5. Remove the two screws located on the outside of the electronics cover.

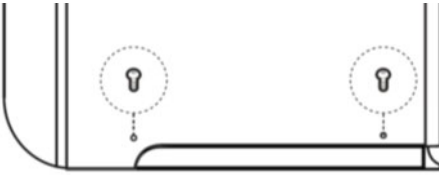

6. Remove the electronics cover.

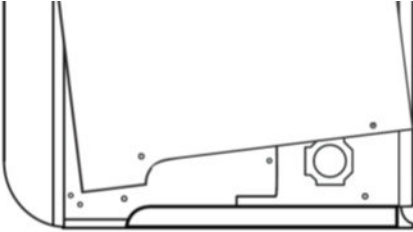

7. Remove the two screws on the back of the printer securing the cover plate and remove the cover plate.

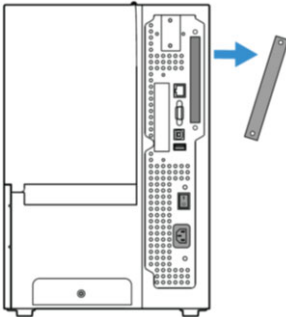

8. Use the T10 screwdriver to remove the screw located on the top of the printer main board and replace with spacer screw.

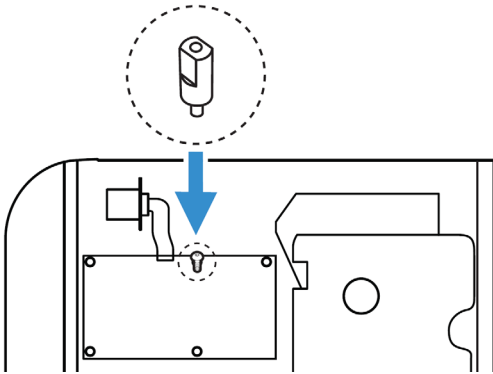

9. Insert the Applicator Interface Board into the printer and secure the board assembly to the printer with two torx screws.

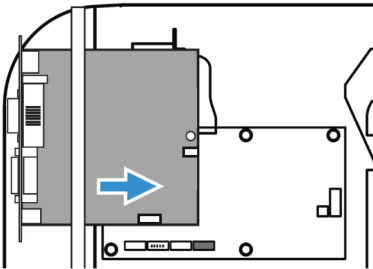

10. Secure the interface board assembly to the spacer screw with a Torx screw.
11. Insert the USB cable and power cable into the J37 and J33 connectors on the printer main board. Then insert the other ends into the J1 and J2 connectors on the Applicator Interface Board.

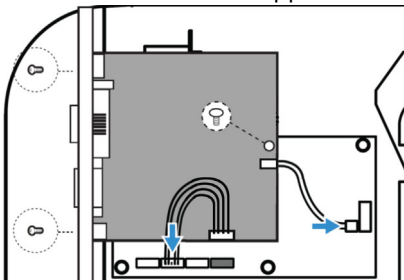

12. Put the electronics cover back on and secure it with the 4 screws.

Interfacing

This option board contains 4 connectors for a Z-Style Port, a S-Style Port, an External Power Port, and an External Error Port.

Port	Description
Z-Style	A D-Sub 15Pin receptacle connector.
S-Style	A D Shaped SCSI 14Pin connector.
External Power	A Mini-DIN 6Pin receptacle connector.
External Error	A Mini-DIN 8Pin receptacle connector.

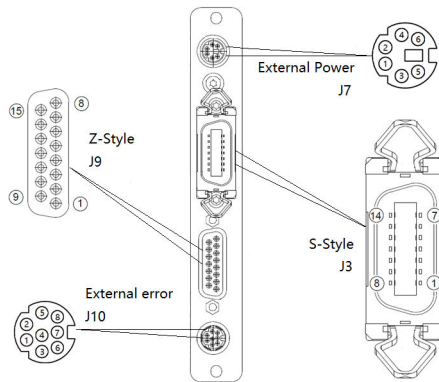

Z-Style Port

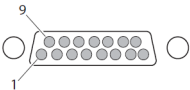

Z-Style Port Pinouts

Pin	Signal	Type	Description
1	Signal ground	Ground	configurable for internal or external source
2	+5VDC	Power	Voltage supply for external sensors. Configurable for internal or external source.

Pin	Signal	Type	Description
3	Start print	Input	<p>Pulse Mode - prints one and only one label whenever this pin is pulled to ground. Signal must be de-asserted and reasserted to print another label.</p> <ul style="list-style-type: none"> • Printing starts on HIGH to LOW transition if format is ready. • De-assert this signal to HIGH to inhibit printing. <p>Level Mode - prints labels continuously when this pin is pulled to ground. Printing is disabled when signal is de-asserted. If a label is printing when de-asserted, printing stops after the label is complete.</p> <ul style="list-style-type: none"> • Assert LOW to start printing if format is ready. • De-assert HIGH when current label has finished printing. Remains de-asserted while waiting for the next label to be ready to print.
4	Feed	Input	Assert LOW to feed label stock. De-assert HIGH to stop feeding labels.
5	Pause	Input	Assert LOW for 200ms and then de-assert HIGH to toggle between pause and un-pause states.
6	Reprint	Input	Enables Reprint mode via software. When this mode is enabled, assert LOW to reprint last label. This input is ignored when reprint mode is disabled.
7	+24VDC	Output	Power for external devices: +24VDC ($\pm 10\%$) @ 2A.
8	Power ground	Ground	+24VDC return.
9	Ribbon/ Media low	Output	Goes LOW when the ribbon/media roll diameter drops below a predefined level, otherwise Goes HIGH. Media low is supported only by I-Style.

Pin	Signal	Type	Description
10	Service required	Output	Goes LOW during every status that keeps the printer from printing: <ul style="list-style-type: none"> • Printhead lifted • Ribbon out • Media out • General print engine fault • Front arm lifted • Verifier calibration required • Verifier calibration expired • Exceed maximum barcodes • Verifier hardware error • Verifier failure action prompt
11	End print	Output	Drives an applicator or other external device requiring synchronization with the print cycle. Choose between five types of output signals: <ul style="list-style-type: none"> • Mode 0: Applicator port is OFF. • Mode 1: Asserted LOW only when media is moving, otherwise de-asserted HIGH. • Mode 2: Asserted HIGH only when media is moving, otherwise de-asserted LOW. • Mode3 (Default): Asserted LOW for 20ms when label has finished printing and positioned. Not asserted during continuous printing. • Mode 4: Asserted HIGH for 20 ms when label has finished printing and positioned. Not asserted during continuous printing.
12	Media out	Output	Goes LOW when the printer is out of media.
13	Ribbon out	Output	Goes LOW when the printer is out of ribbon.
14	Data ready	Output	Goes LOW when ready to print. De-asserted HIGH when printing stops after the current label.
15	Verification failed	Output	Goes LOW when the printer encounters Verification failed error. Goes HIGH when the error is cleared.

S-Style Port

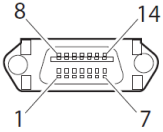

S-Style Port Pinouts

Pin	Signal	Type	Description
1	Media out	Output	Goes LOW when the printer is out of media.
2	Signal ground	Ground	Configurable for internal or external source.
3	Ribbon out	Output	Goes LOW when the printer is out of ribbon.
4	Error	Output	Goes LOW during every status that keeps the printer from printing: <ul style="list-style-type: none"> • Printhead lifted • Ribbon out • Media out • General print engine fault • Front arm lifted • Verifier calibration required • Verifier calibration expired • Exceed maximum barcodes • Verifier hardware error • Verifier failure action prompt

Pin	Signal	Type	Description
5	Start print	Input	<p>Pulse mode - prints one and only one label whenever this pin is pulled to ground. Signal must be de-asserted and re-asserted to print another label.</p> <ul style="list-style-type: none"> • Printing starts on HIGH to LOW transition if format is ready. • De-assert this signal to HIGH to inhibit printing. <p>Level mode - prints labels continuously when this pin is pulled to ground. Printing is disabled when signal is de-asserted. If a label is printing when de-asserted, printing stops after that label is complete.</p> <ul style="list-style-type: none"> • Assert LOW to start printing if format is ready. • De-asserted HIGH when current label has finished printing. Remains de-asserted while waiting for next label to be ready to print.
6	End print	Output	<p>Drives an applicator or other external device requiring synchronization with the print cycle. Choose between four types of output signals:</p> <ul style="list-style-type: none"> • Type 1 (Default): Asserted LOW for 20ms when label has finished printing and positioned. Not asserted during continuous printing. • Type 2: Asserted HIGH for 20ms when label has finished printing and positioned. Not asserted during continuous printing. • Type 3: Asserted LOW only when media is moving, otherwise de-asserted HIGH. • Type 4: Asserted HIGH only when media is moving, otherwise de-asserted LOW.
7	Reprint	Input	<p>Enables Reprint mode via software. When this mode is enabled, assert LOW to reprint last label. This input is ignored when Reprint mode is disabled.</p>
8	Reserved		

Pin	Signal	Type	Description
9	Reserved		
10	Ribbon/ Media low	Output	Goes LOW when the ribbon/media roll diameter drops below a predefined level, otherwise Goes HIGH. Media low is supported only by I-Style.
11	Verification failed	Output	Goes LOW when the printer encounters Verification failed error. Goes HIGH when the error is cleared.
12	+24VDC	Output	Power for external devices: +24VDC ($\pm 10\%$) @2A.
13	+5VDC	Power	Voltage supply for external sensors. Configurable for internal or external source.
14	Power ground	Ground	+24VDC return.

External Power Port

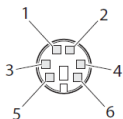

External Power Port Pinouts

Pin	Signal	Type	Description
1	+5VDC	Input	+5VDC input for distribution through Applicator Port connector (Z-Style pin 2, S-Style pin 13)
2	Signal ground	Input	Signal return for +5VDC supply (Z-Style pin 1, S-Style pin 2)
3	+24VDC	Input	+24VDC input for distribution through Applicator Port connector (Z-Style pin 7, S-Style pin 12)
4	Power ground	Input	Power return for input (Z-Style pin 8, S-Style pin 2)
5	+24VDC	Input	+24VDC input for distribution through Applicator Port connector (Z-Style pin 7, S-Style pin 12)

Pin	Signal	Type	Description
6	Power ground	Input	Power return for input (Z-Style pin 8, S-Style pin 2)

External Error Port

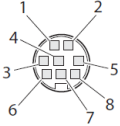

External Error Port Pinouts

Pin	Signal	Type	Description
1	AppErr_1	Input	Applicator error #1, reserved for external applicator device to signal error for printer to receive status of applicator.
2	AppErr_2	Input	Applicator error #2, reserved for external applicator device to signal error for printer to receive status of applicator.
3	AppErr_3	Input	Applicator error #3, reserved for external applicator device to signal error for printer to receive status of applicator.
4	RtW_in_Ext	Input	External input signal from the applicator to the printer, for the printer to switch to the same state with the applicator, and behave in sync as part of the entire system.
5	+5VDC	Output	Available for applicator.
6	RtW_Out	Output	External output signal indicating the printer is Ready to Work. Signal may be asserted LOW when there are no active events in the System Health Monitor (SHM), when the printer motor is idle, or both.
7	Ground	Ground	Available for applicator.
8	Ground	Ground	Available for applicator.

Applicator Signals

The diagrams below show how applicator signals function in each applicator mode during the stages of printing labels.

End Print Mode 1/Type 3

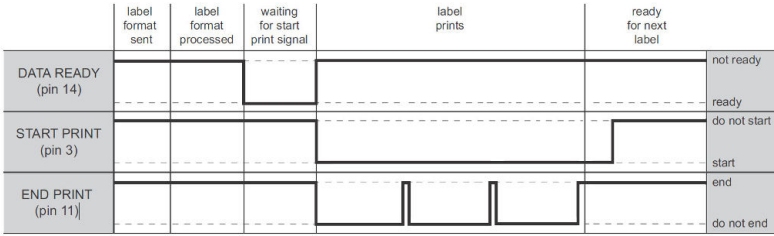

End Print Mode 2/Type 4

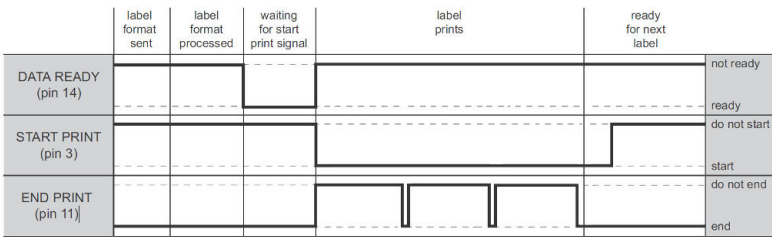

End Print Mode 3/ Type 1

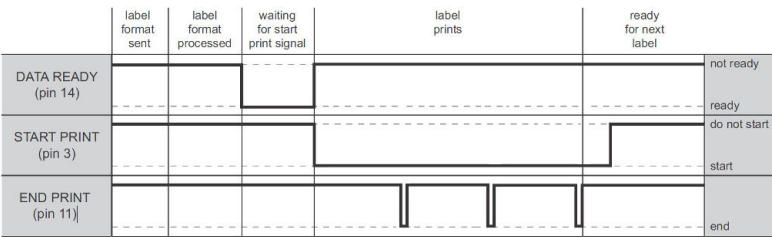

End Print Mode 4/ Type 2

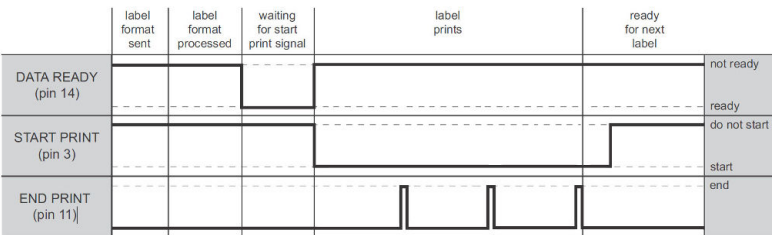

Configuring Applicator Port Settings

The applicator interface supports three different applicator modes:

- Z-Style. Choose this mode for a Zebra-type applicator.
- S-Style. Choose this mode for a Sato-type applicator.
- I-Style. This mode combines Z-Style or S-Style settings with the ability to trigger external I/O systems via the External Error port.

You can configure applicator port settings from the web browser interface or in Setup Mode.

Web Browser Interface

1. From the menu, click **System Settings > Manage I/O**. The configuration screen appears.
2. Chose **Enable** from the drop down list for the Applicator.
3. From the menu, click **Configure > Printing > Applicator**.
4. Choose desired settings from the drop down lists.

Setting	Description
Style	I-Style, Z-Style, S-Style
Startprint	Level or Pulse
Endprint	Mode 0, Mode 1/Type3, Mode2/Type4, Mode3/Type 1, Mode 4/Type 2
Ribbon/Media Low	Enables/disables the printer low ribbon alert message. Enables/disables the printer low media alert message.
Reprint	Enables/disables reprinting the last label sent to the printer (by using the Reprint signal)
Error on Pause	Enable this setting to set the "Service Required" signal when the printer is paused. This setting supported by Z-Style only.
Error Port	Enables/disables the printer external error port.
RTW	Configures the Ready-to-Work output signal (RTWOUTEXT). Choose from: <ul style="list-style-type: none"> • Mode 1 - Signal is asserted low when no events are active in the System Health Monitor (SHM). • Mode 2 - Signal is asserted low when the printer motor is idle. • Mode 3 - Signal is asserted low when the printer motor is idle and no events are active in the SHM.
DC 5V	Configures the printer to use either its internal power supply or an external supply (connected to the External Power port) to provide +5VDC to the Z-Style and S-Style ports.

Setting	Description
DC 24V	Configures the printer to use either its internal power supply or an external supply (connected to the External Power port) to provide +24VDC to the Z-Style and S-Style ports.

5. Click **Save**. The settings are saved.

Setup Mode

Use the printer touch screen to view and change settings.

1. Press **Menu > Settings > System Settings > Manage I/O**.
2. Choose **Enable** from the drop-down list for the applicator.
3. From the menu, select **Menu > Settings > Printing > Applicator**.

About Applicator Input Signals

This section describes the INPUT signals.

Note: All IN signals are asserted low and de-asserted high.

Signal	Description
Startprint	Starts a print job. Choose either Level or Pulse. <ul style="list-style-type: none"> • Level: The printer starts printing labels when the startprint signal is asserted and continues printing until the signal is de-asserted. • Pulse: The printer prints one label when the startprint signal is asserted. The startprint signal must be de-asserted and then asserted to print the next label.
Feed	Feeds a single label. Not supported by S-Style.
Pause	Toggles between Pause mode and printing. Not supported by S-Style.
Reprint	Reprints the last valid label.
Apperr1	Applicator error 1.
Apperr2	Applicator error 2.
Apperr3	Applicator error 3.
RTWINEXT	External input signal, which you can use to monitor the operational status of the entire system.

About Applicator OUT Signals

This section describes the Applicator OUT signals.

Note: Unless described otherwise, all OUT signals are asserted low and de-asserted high.

Signal	Description
Data Ready	Asserted when the printer is ready to receive a startprint signal and execute the current print job. De-asserted when the print cycle ends. Not supported by S-Style.
Endprint	Asserted during or after a print cycle. The endprint signal also behaves differently depending on the applicator port endprint mode. When the startprint signal is received, the endprint signal may or may not be asserted. There are five options to choose from: <ul style="list-style-type: none">• Mode 0: Endprint signal is never asserted.• Mode 1 (Z-Style)/Type 3 (S-Style): Asserted low during print/feed cycle.• Mode 2 (Z-Style)/Type 4 (S-Style): Asserted high during print/feed cycle.• Mode 3 (Z-Style)/Type 1 (S-Style): Asserted low for at least 20 ms after print/feed cycle end.• Mode 4 (Z-Style)/Type 2 (S-Style): Asserted high for at least 20 ms after print/feed cycle end.
Media out	Asserted when the printer is out of media. Activates an SHM PaperOut event in the System Health Monitor (SHM). De-asserted when the same event is deactivated.
Ribbon/Media low	Asserted when the ribbon/media roll diameter drops below a predefined level. De-asserted while the roll diameter remains above the predefined level. Media low is supported only by I-Style.
Ribbon out	Asserted when the printer is out of ribbon. Activates an SHM RibbonOut event in the System Health Monitor (SHM). De-asserted when the same event is deactivated.

Signal	Description
RTWOUTEXT	External output signal. Behavior depends on the current setup. Signal may be asserted when there are no active events in the System Health Monitor (SHM), when the printer motor is idle, or both. This signal is inactive when the Error Port option is disabled.
SERVICEREQ (Service Required)	Asserted low when an event in the System Health Monitor (SHM) is activated. De-asserted when no events are active in the SHM. A "service required" event is also activated when the Error Port is enabled and any applicator errors is detected. This signal is also asserted when the Error on Pause option is enabled.

Programming Applications for the printer

The printer includes Honeywell Fingerprint, a programming language that resides on the printer. Fingerprint is an easy-to-use programming tool for label formatting and printer customization.

Fingerprint also includes a slave protocol, Honeywell Direct Protocol, which allows layouts and variable data to be downloaded from a host and combined into labels, tickets, and tags with a minimum of programming. Honeywell Direct Protocol also includes a versatile error handler and a flexible counter function.

Fingerprint Commands for the printer

The ON PORTIN, PORTIN, PORTOUT, and ON PORTOUT Fingerprint commands support applicator functionality for the printer. These commands are functional when the printer applicator port status is enabled.

This section includes basic information for each of these commands. For more information, see the Fingerprint Command reference manual.

ON PORTIN

This command allows a Fingerprint application to detect in signals. If a particular in signal is asserted, the application moves to the subroutine responsible for carrying out tasks related to that in signal. One command is available for detection of each of the 8 in signals.

Note: *This command is not supported by Honeywell Direct Protocol.*

Example:

- ON PORTIN.STARTPRINT GOSUB nnn

PORTIN

This command is a version of the PORTIN(PORT) command and checks the current state of a specified signal. This command returns -1 if the signal is asserted, or 0 if the signal is de-asserted.

Note: *This command is supported by Fingerprint and Direct Protocol.*

Examples:

- PORTIN.STARTPRINT
or
- PORTIN.RIBBONLOW

PORTOUT

Supports manually modifying the dataready signal. PORTOUT is not allowed when the applicator port style is set to S-Style.

Note: *This command is not supported by Direct Protocol.*

Example

- PORTOUT.DATAREADY ON
- PORTOUT DATAREADY OFF

where *on* asserts the dataready signal low and *off* de-asserts the dataready signal high.

ON PORTOUT

This command allows a Fingerprint application to detect when out signals have been reset to default values. The command moves to a specified subroutine whenever the applicator port status is enabled, and whenever the applicator port style is changed.

Example:

- ON PORTOUT.RESET GOSUB nnn

Using External Applicator Signals

The printer responds to external applicator port signals differently, depending on whether your application is using Fingerprint or Honeywell Direct Protocol.

Fingerprint and Applicator Signals

When you use Fingerprint, all in signals and the Data-ready out signal are handled by Fingerprint. Other out signals are handled by firmware.

Feed

When the Feed in signal is received, the application moves to a specified sub-routine that feeds labels until the Feed in signal is de-asserted.

Example

- 10 ON PORTIN.FEED GOSUB 200
...
200 FORMFEED
210 RETURN

Pause

When the Pause in signal is received, the application moves to a specified sub-routine that finishes the current print job and then places the printer in pause mode.

Example

- 10 ON PORTIN.PAUSE GOSUB 90
...
90 pause printer

Startprint

When the Startprint signal is received, the application moves to a specified subroutine that starts the print job. The Startprint signal must be preceded by the dataready signal as seen in this example.

Example

- 10 PORTOUT.DATAREADY on
20 ON PORTIN.STARTPRINT GOSUB 60
...
60 my print routine
70 PRINTFEED
80 RETURN

Reprint

When the Reprint signal is received, the application moves to a specified sub-routine that reprints the last valid label.

Example:

- ...
100 ON PORTIN.REPRINT GOSUB 150
...
150 PRINTFEED -1,1
160 RETURN

Printfeed

The dataready signal must be set manually by the Fingerprint application before a printfeed is issued when using with an applicator.

Handling External Applicator Errors

When an error signal (apperr1, apperr2, or apperr3) is received, the application moves to a specified subroutine that takes action based on error severity.

Example

- ...
60 ON PORTIN.APPERR1 GOSUB 100
...
100 perform error handling
110 RETURN

Handling Internal System Errors

For internal system errors, the system error signal status can be read at any time within the application so appropriate measures can be taken. When any of these errors occur, the appropriate out signal (including the error) is asserted:

- Printhead lifted
- Ribbon out
- Media out
- General print engine fault
- Front arm lifted
- Verifier calibration required
- Verifier calibration expired
- Exceed maximum barcodes
- Verifier hardware error
- Verifier failure action prompt

Example

- 10 IF PORTIN.RIBBONLOW GOTO 200
...

200 perform error handling
210 RETURN

Resetting Out Signals

Out signals are reset to their default values when certain options are changed by using the SETUP menu. When the reset is detected, the application moves to a specified subroutine and performs the tasks necessary to reinitialize the print engine.

Example

- 10 ON PORTOUT.RESET GOSUB 150
...
150 perform initialization
160 RETURN

Direct Protocol and Applicator Signals

In Direct Protocol, all in and out signals are handled by the Direct Protocol firmware.

Feed

There are two ways to trigger blank label feeding:

- by manually pressing Feed on the printer front panel. The printer feeds a single blank label.
- by using the Feed in signal. When this signal is detected, the printer feeds blank labels as long as internal applicator flag indicates that the Feed signal is asserted.

Pause

The applicator can toggle the current pause state by using the pause in signal to simulate pressing Pause on the printer front panel. When the printer is in pause state, you can press Setup on the printer front panel and place the print engine in Setup Mode for manual configuration.

Startprint

When the printfeed command is executed, the print process sets the dataready signal and then waits for the startprint signal to be detected before proceeding with the print job.

The print process will not set another dataready signal until the current print job de-asserts the previous dataready signal. This prevents the printer from printing a new label before the previous label is completed.

Reprint

This signal works much the same way as startprint. The reprint signal is detected under two conditions:

- when the printer is idle.
- when the printer is waiting for a startprint signal during the execution of a printfeed command.

The printer prints only one label at a time.

Handling External Applicator Errors

The external applicator error in signals (APPERR1, APPERR2, APPERR3, RTWINEXT) should be asserted when external applicator errors occur. When one of these signals is detected, an associated event is activated in the System Health Monitor (SHM). When the issue causing the error has been resolved and the error signals are de-asserted, the events are deactivated in the SHM.

Handling Internal System Errors

When a system error occurs that activates an event in the SHM, the “service required” signal is asserted. The external RTW out signal can be de-asserted, depending on the current print engine RTW setting.

When any of these errors occur, the appropriate out signal (including the error) is asserted:

- Printhead lifted
- Ribbon out
- Media out
- General print engine fault
- Front arm lifted
- Verifier calibration required
- Verifier calibration expired
- Exceed maximum barcodes
- Verifier hardware error
- Verifier failure action prompt

Error Messages

ERRNOAPP

Message: Operation not allowed. Applicator Port disabled.
Cause: Application sent an applicator port command to the printer and the applicator port is disabled.
Error Number: 88

ERRAPP

Message: Operation not allowed. Applicator Port enabled.
Cause: Application sent the Fingerprint command PORTOUT(PORT) ON/OFF on a port used by the applicator port when the applicator port is enabled.
Error Number: 89

ERRINPUTON

Message: Operation not allowed in Direct Protocol.
Cause: Running the PORTOUT.DATAREADY ON/OFF or PORTIN.<SIGNAL> GOSUB XXX commands when the printer is using Direct Protocol.
Error Number: 90

EAPPERR1

Message: Applicator Error 1.
Cause: AppErr1 in signal detected.
Result: Activates event in System Health Monitor (SHM).
Error Number: 1340

EAPPERR2

Message: Applicator Error 2.
Cause: AppErr2 in signal detected.

Result: Activates event in System Health Monitor (SHM).
Error Number: 1341

EAPPERR3

Message: Applicator Error 3.
Cause: AppErr3 in signal detected.
Result: Activates event in System Health Monitor (SHM).
Error Number: 1342

ERTWINEXT

Message: RTW Extenal Error.
Cause: RTWExternal in signal detected.
Result: Activates event in System Health Monitor (SHM).
Error Number: 1343

ENODATAREADY

Message: Dataready not enabled.
Cause: Application sent a PRINTFEED in Fingerprint when the applicator port is enabled, the style is set to I-Style or Z-Style, and the dataready signal is not enabled.
Result: Terminates the printfeed command without printing a label.
Error Number: 1344

Display Messages

These messages appear in the printer display under certain conditions when a PRINTFEED command is run.

Message: APPLICATOR PORT: Wait for signal.
Running a PRINTFEED command blocks execution until a startprint signal is received. The message appears when execution has been blocked for a few seconds.

Cause:

Message: APPLICATOR PORT: Wait for reprint.
Running a PRINTFEED -1,1 command blocks execution until a reprint signal is received. The message appears when execution has been blocked for a few seconds.

Cause:

Support

To search our knowledge base for a solution or to log into the Technical Support portal and report a problem, go to www.hsmcontactsupport.com.

User Documentation

For the user guide and other documentation, go to www.honeywellaidc.com.

Limited Warranty

For warranty information, go to www.honeywellaidc.com and click **Get Resources > Product Warranty**.

Patents

For patent information, see www.hsmpats.com.

Disclaimer

Honeywell International Inc. (“HII”) reserves the right to make changes in specifications and other information contained in this document without prior notice, and the reader should in all cases consult HII to determine whether any such changes have been made. The information in this publication does not represent a commitment on the part of HII.

HII shall not be liable for technical or editorial errors or omissions contained herein; nor for incidental or consequential damages resulting from the furnishing, performance, or use of this material. HII disclaims all responsibility for the selection and use of software and/or hardware to achieve intended results.

This document contains proprietary information that is protected by copyright. All rights are reserved. No part of this document may be photocopied, reproduced, or translated into another language without the prior written consent of HII.

Copyright © 2009-2020 Honeywell International Inc. All rights reserved.